



60V/100A N-Channel Advanced Power MOSFET

Features

- Excellent package for heat dissipation
- High density cell design for low RDS(ON)

BVDSS	60	V
ID	100	A
RDSON@VGS=10V	1.9	mΩ
RDSON@VGS=4.5V	2.6	mΩ

Applications

- Load Switch
- Power management functions
- PWM Application

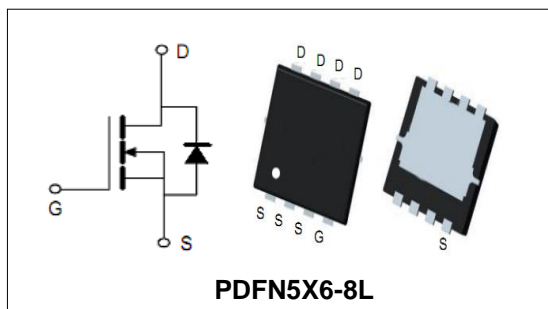

Order Information

Product	Package	Marking	Reel Size	Reel	Carton
PGN06N026	PDFN5X6-8L	PGN06N026	13inch	5000PCS	50000PCS

Absolute Maximum Ratings

Symbol	Parameter	Rating	Unit	
Common Ratings (TC=25°C Unless Otherwise Noted)				
$V_{(BR)DSS}$	Drain-Source Breakdown Voltage	60	V	
V_{GS}	Gate-Source Voltage	±20	V	
T_J	Maximum Junction Temperature	150	°C	
T_{STG}	Storage Temperature Range	-55 to 150	°C	
I_S	Diode Continuous Forward Current	TC =25°C	100	A
Mounted on Large Heat Sink				
E_{AS}	Avalanche Energy, Single Pulsed (Note1)	306	mJ	
I_{DM}	Pulse Drain Current Tested (Silicon Limit) (Note2)	TC =25°C	400	A
I_D	Continuous Drain current	TC =25°C	100	A
P_D	Maximum Power Dissipation	TC =25°C	106	W
$R_{θJc}$	Thermal Resistance Junction-to-Case (Note3)	1.18	°C/W	



60V/100A N-Channel Advanced Power MOSFET

Symbol	Parameter	Condition	Min.	Typ.	Max.	Unit
Static Electrical Characteristics @ T_J = 25°C (unless otherwise stated)						
V _{(BR)DSS}	Drain- Source Breakdown Voltage	VGS=0V ID=250μA	60	--	--	V
I _{DSS}	Zero Gate Voltage Drain current	VDS=60V,VGS=0V	--	--	1	μA
I _{GSS}	Gate-Body Leakage Current	VGS=±20V,VDS=0V	--	--	±100	nA
V _{GS(TH)}	Gate Threshold Voltage	VDS=VGS,ID=250μA	1	1.6	2.5	V
R _{DS(ON)}	Drain-Source On-State Resistance (Note4)	VGS=10V, ID=30A	--	1.9	2.6	mΩ
		VGS=4.5V, ID=20A	--	2.6	3.4	
Dynamic Electrical Characteristics @ T_J = 25°C (unless otherwise stated) (Note5)						
C _{iss}	Input Capacitance	VDS=25V, VGS=0V, F=1MHz	--	5441	--	pF
C _{oss}	Output Capacitance		--	2201	--	pF
C _{rss}	Reverse Transfer Capacitance		--	136	--	pF
Q _g	Total Gate Charge	VDS=30V, ID=30A, VGS=10V	--	101	--	nC
Q _{gs}	Gate-Source Charge		--	17	--	nC
Q _{gd}	Gate-Drain Charge		--	22	--	nC
Switching Characteristics (Note5)						
t _{d(on)}	Turn-on Delay Time	VDD=30V, ID=30A, VGS=10V RGEN=3Ω	--	16	--	nS
t _r	Turn-on Rise Time		--	38	--	nS
t _{d(off)}	Turn-off Delay Time		--	78	--	nS
t _f	Turn-off Fall Time		--	95	--	nS
Source- Drain Diode Characteristics @ T_J = 25°C (unless otherwise stated)						
V _{SD}	Forward on voltage	IS=30A,VGS=0V	--	--	1.2	V
t _{rr}	Reverse Recovery Time	IF=30A,VGS=0, dI/dt=100A/us	--	54.7	--	nS
Q _{rr}	Reverse Recovery Charge		--	60	--	nC

Note:

- Limited by T_{Jmax}, starting T_J = 25° C, R_G = 4.5Ω, V_D =30V, V_{GS} =10V. Part not recommended for use above this value.
- Repetitive Rating: Pulse width limited by maximum junction temperature.
- Surface Mounted on FR4 Board, t ≤ 10 sec.
- Pulse Test: pulse width ≤ 300 us, duty cycle ≤ 2%.
- Guaranteed by design, not subject to production testing.



60V/100A N-Channel Advanced Power MOSFET

Typical Characteristics

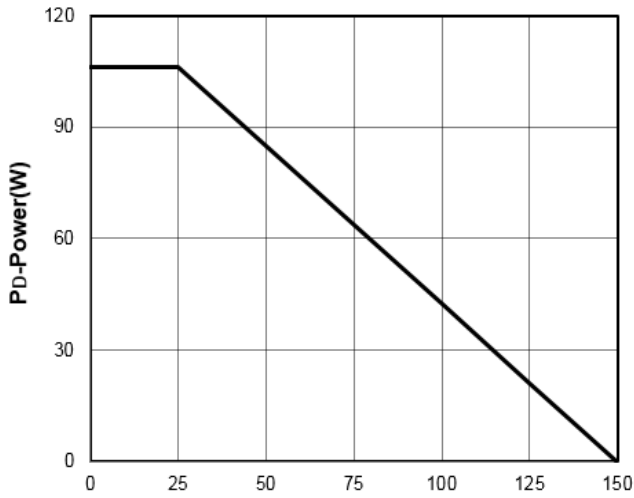

Figure1: T_J-Junction Temperature (°C)

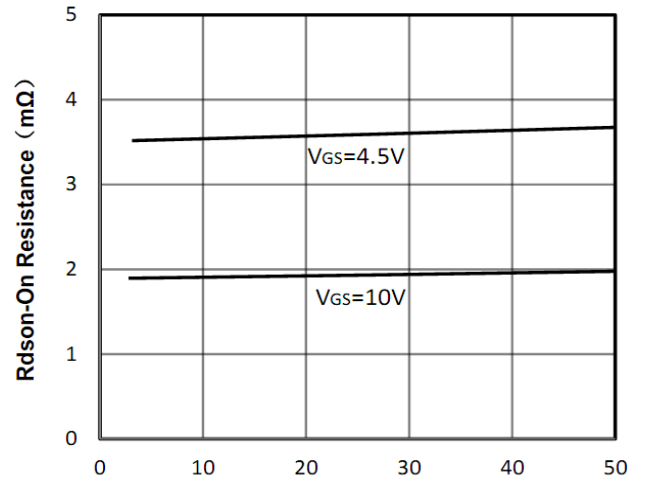

Figure2: I_D-Drain Current (A)

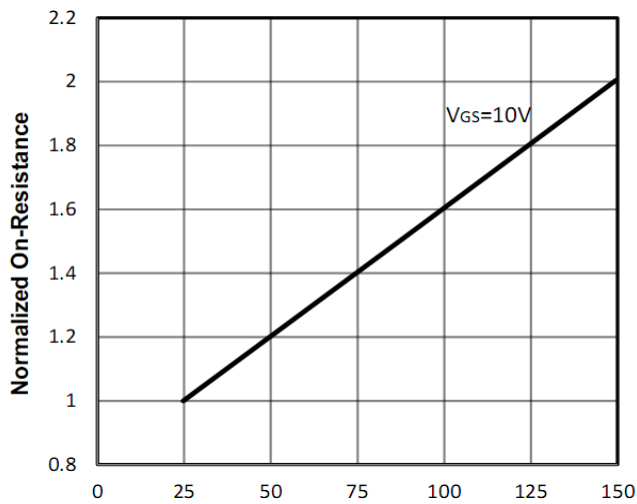

Figure3: T_J-Junction Temperature (°C)

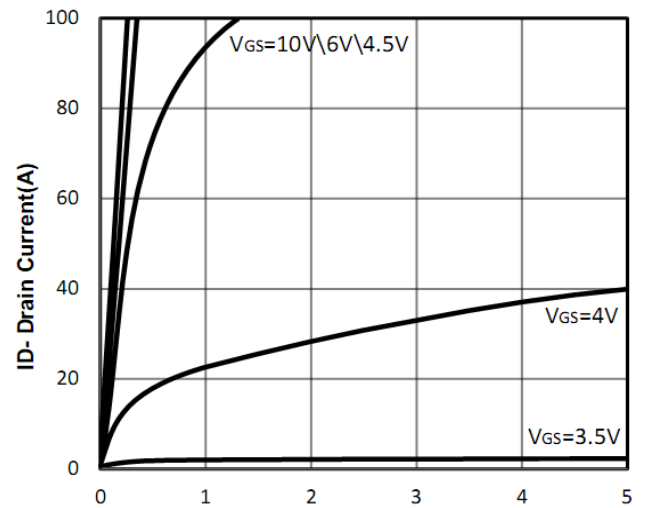

Figure4: V_{DS}-Drain Source Voltage (V)

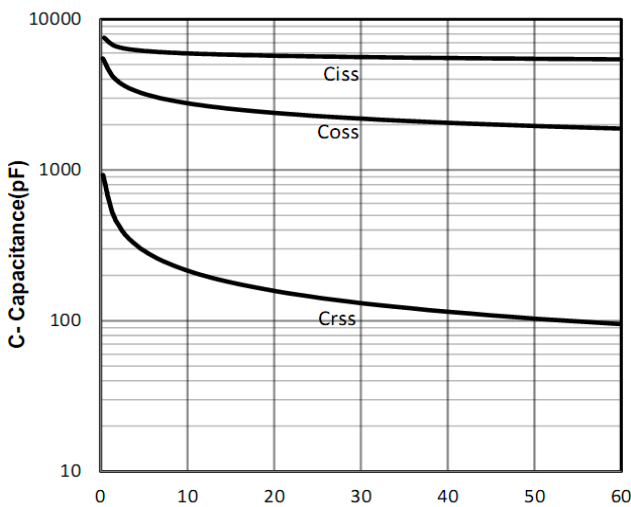

Figure5: V_{DS}-Drain Source Voltage (V)

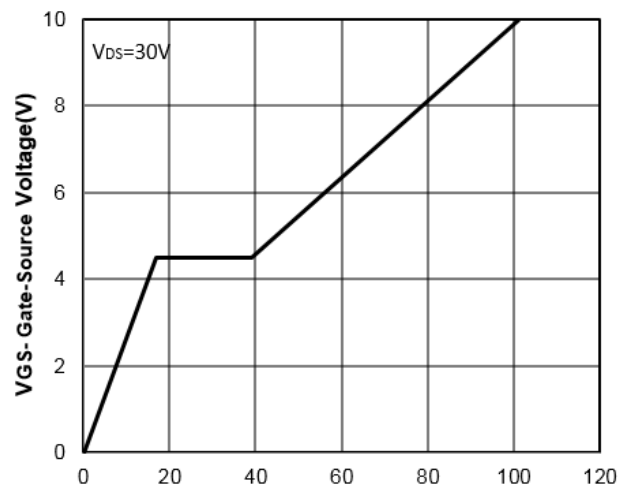

Figure6: Q_g-Gate Charge (nC)



60V/100A N-Channel Advanced Power MOSFET

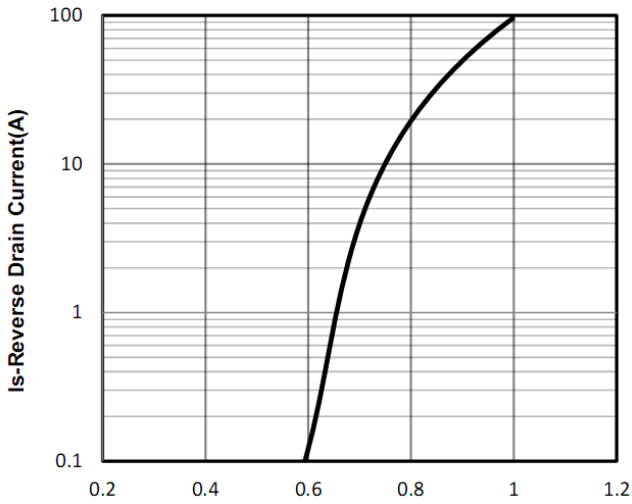

Figure7: Vsd -Source Drain Voltage (V)

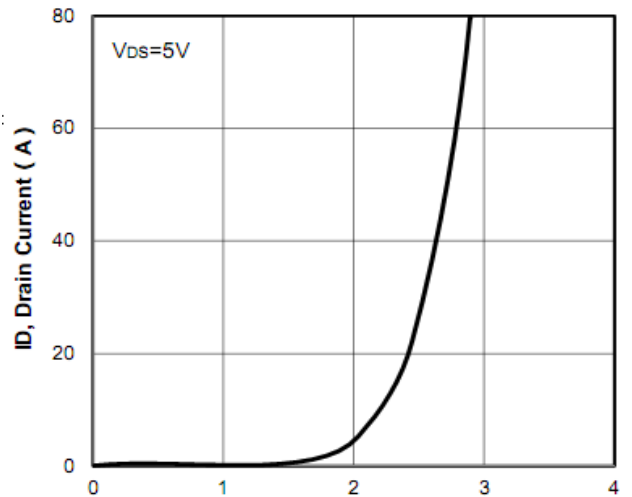

Figure8: Vgs -Gate Source Voltage (V)

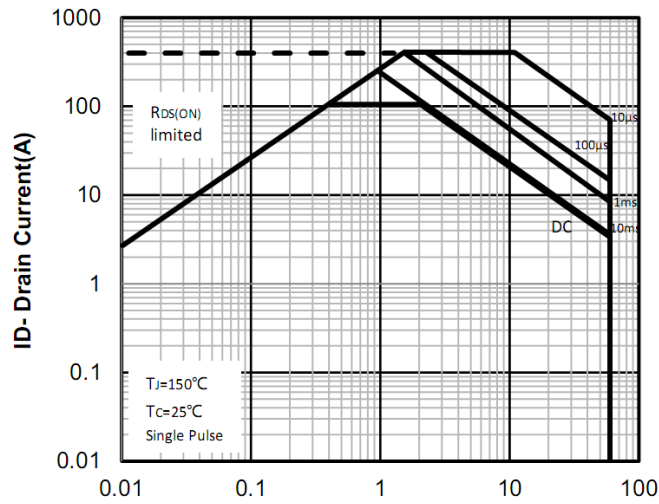

Figure9: VDS -Drain Source Voltage (V)

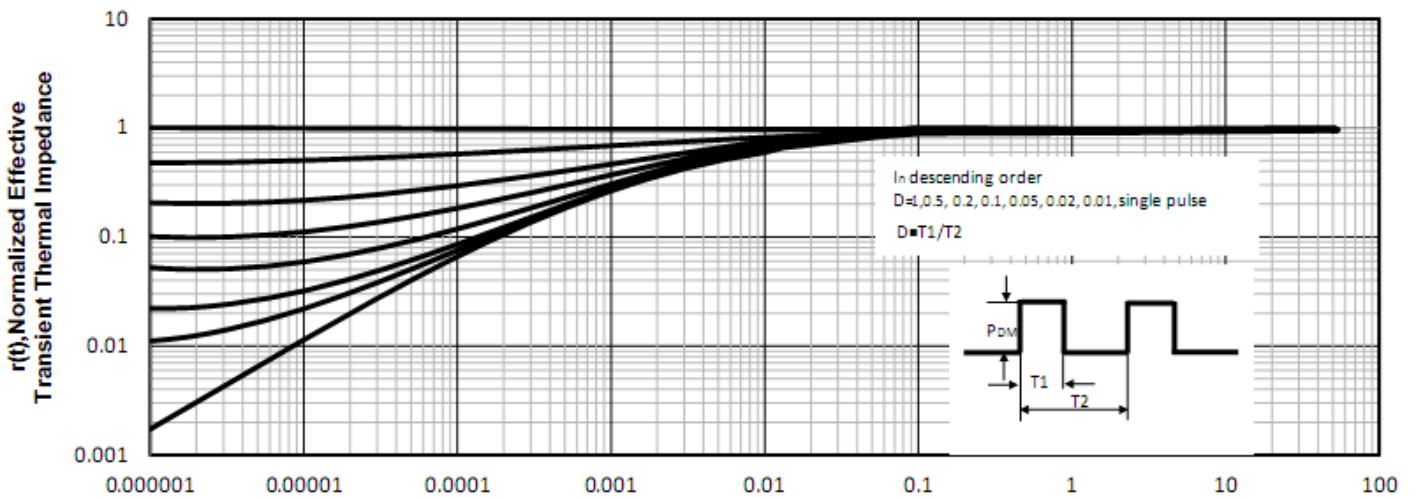

Figure10: Square Wave Pulse Duration (sec)

60V/100A N-Channel Advanced Power MOSFET

Test Circuit and Waveform:

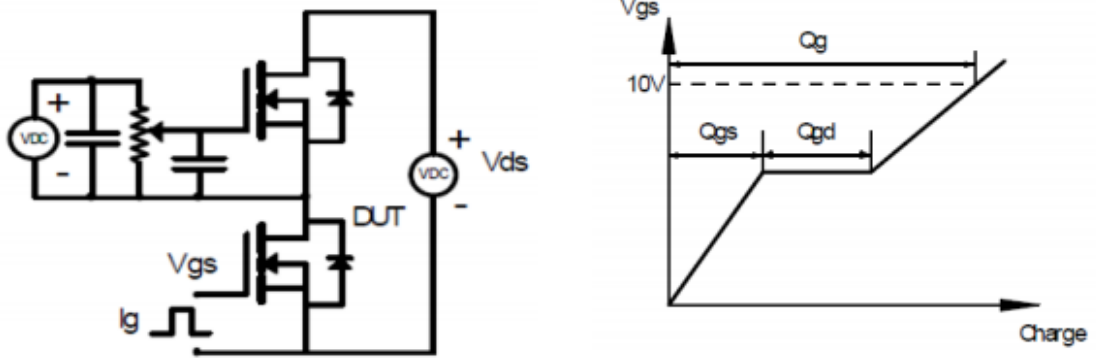

Figure A Gate Charge Test Circuit & Waveforms

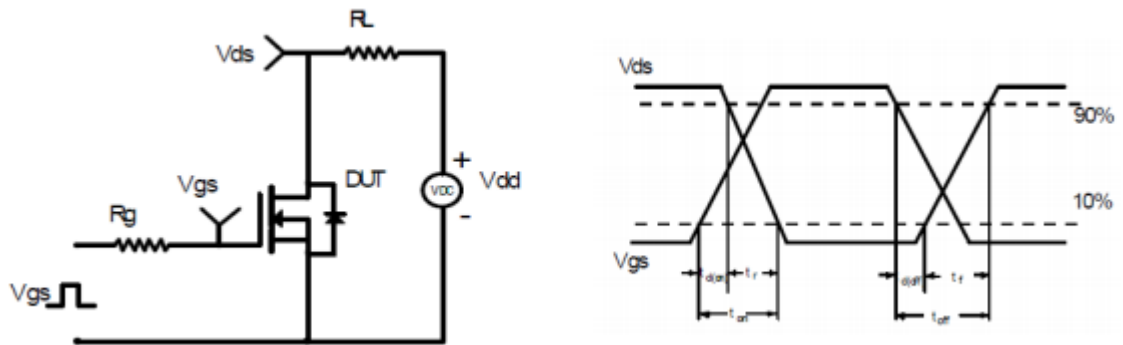

Figure B Switching Test Circuit & Waveforms

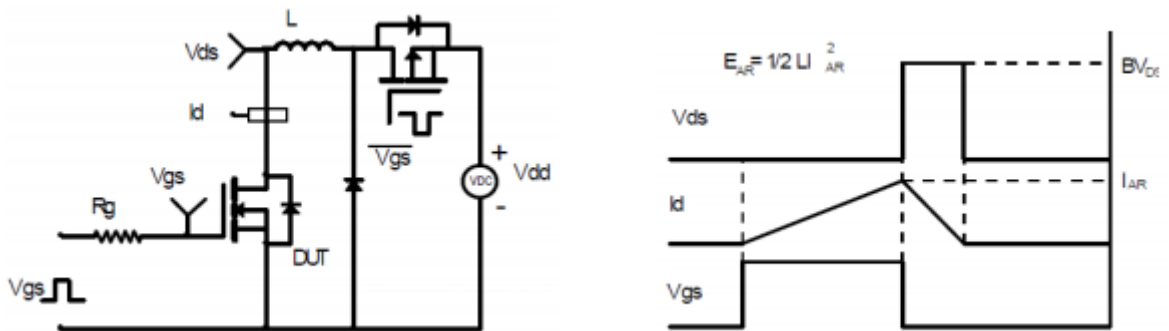
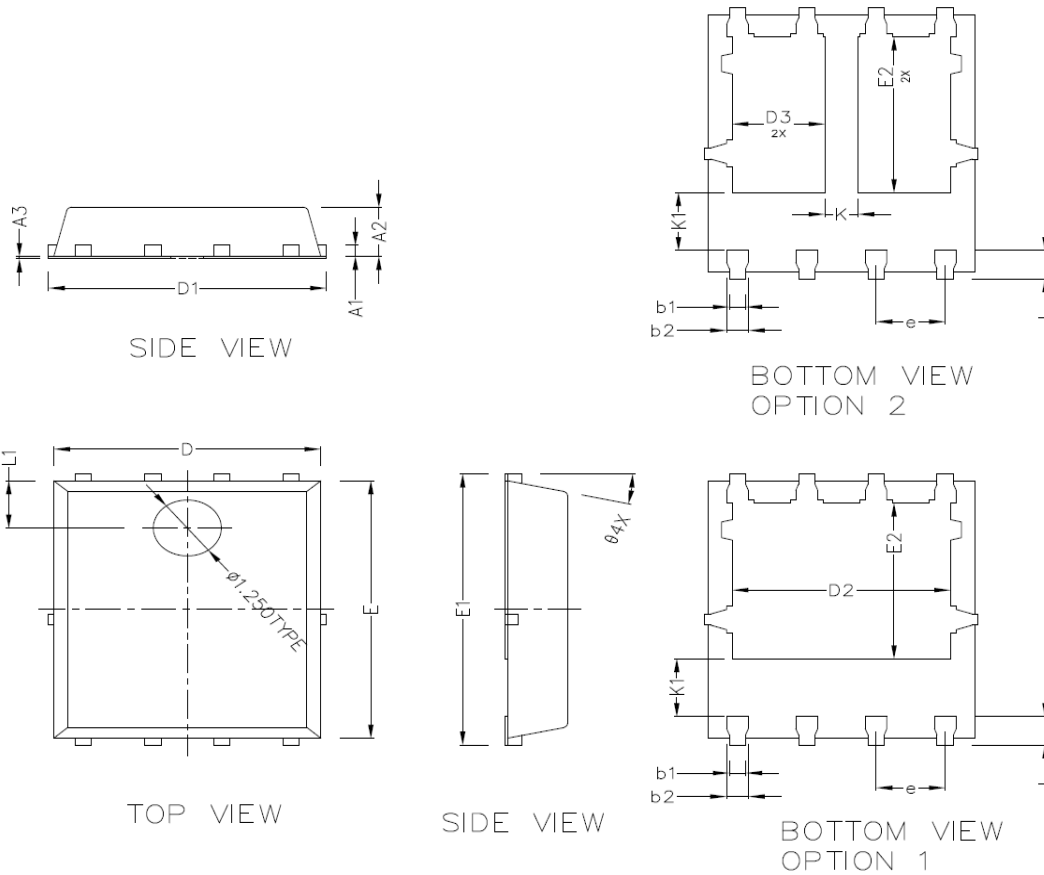

Figure C Unclamped Inductive Switching Circuit & Waveforms



60V/100A N-Channel Advanced Power MOSFET

PDFN5X6-8 Package Outline Dimensions (Units: mm)



COMMON DIMENSIONS (UNITS OF MEASURE IS)			
	MIN	NORMAL	MAX
A1	0.254 BSC		
A2	1.000	1.100	1.200
A3	0.005	-	0.020
b1	0.250	0.300	0.350
b2	0.350	0.400	0.450
D	4.800	4.900	5.000
D1	5.000	5.100	5.200
D2	3.910	4.010	4.110
D3	1.605	1.705	1.805
E	5.650	5.750	5.850
E1	5.950	6.050	6.150
E2	3.375	3.475	3.575
e	1.270 TYPE		
L	0.630	0.630	0.730
L1	1.00REF		
ϕ	1.3' TYPE		
K	0.600 REF		
K1	1.236 REF		