

**30V/5.8A N-Channel Enhancement Mode MOSFET****Features**

- Advanced trench process technology
- High density cell Design For Ultra Low On-Resistance

BVDSS	30	V
ID	5.8	A
RDSON@VGS=10V	19	mΩ
RDSON@VGS=4.5V	25	mΩ

Applications

- Low Side Load Switch
- Battery Switch
- Optimized for Power Management Applications for Portable Products, such as Aeromodelling, Power bank, Brushless motor, Main board , and Others

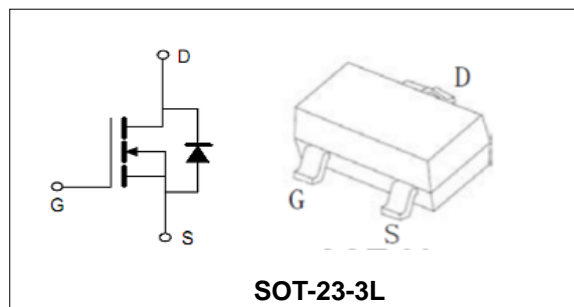
**Order Information**

Product	Package	Marking	Reel Size	Reel	Carton
PT3404	SOT-23-3L	3404Y	7inch	3000PCS	180000PCS

Absolute Maximum Ratings

Symbol	Parameter	Rating	Unit
Common Ratings (TC=25°C Unless Otherwise Noted)			
$V_{(BR)DSS}$	Drain-Source Breakdown Voltage	30	V
V_{GS}	Gate-Source Voltage	±20	V
T_J	Operation Junction Temperature	150	°C
T_{STG}	Storage Temperature Range	-55 to 150	°C
I_S	Diode Continuous Forward Current	$T_A = 25^\circ\text{C}$ 2.5	A
Mounted on Large Heat Sink			
I_{DM}	Pulse Drain Current Tested (Silicon Limit) (Note1)	$T_A = 25^\circ\text{C}$ 30	A
I_D	Continuous Drain current	$T_A = 25^\circ\text{C}$ 5.8	A
P_D	Maximum Power Dissipation	$T_A = 25^\circ\text{C}$ 1.4	W
$R_{\theta JA}$	Thermal Resistance Junction-to-Ambient (Note2)	89.2	°C/W



30V/5.8A N-Channel Enhancement Mode MOSFET

Symbol	Parameter	Condition	Min.	Typ.	Max.	Unit
Static Electrical Characteristics @ T_J = 25°C (unless otherwise stated)						
V _{(BR)DSS}	Drain- Source Breakdown Voltage	VGS=0V ID=250μA	30	--	--	V
I _{DSS}	Zero Gate Voltage Drain current	VDS=30V,VGS=0V	--	--	1	μA
I _{GSS}	Gate-Body Leakage Current	VGS=±20V,VDS=0V	--	--	±100	nA
V _{GS(TH)}	Gate Threshold Voltage	VDS=VGS,ID=250μA	1.1	--	3	V
R _{DS(ON)}	Drain-Source On-State Resistance (Note3)	VGS=10V, ID=5.8A	--	19	30	mΩ
		VGS=4.5V, ID=5A	--	25	41	mΩ
Dynamic Electrical Characteristics @ T_J = 25°C (unless otherwise stated) (Note4)						
C _{iss}	Input Capacitance	VDS= 15V, VGS=0V, F=1MHz	--	437	--	pF
C _{oss}	Output Capacitance		--	68	--	pF
C _{rss}	Reverse Transfer Capacitance		--	59.1	--	pF
Q _g	Total Gate Charge	VDS= 15V, ID= 5.8A, VGS= 4.5V	--	9.7	--	nC
Q _{gs}	Gate-Source Charge		--	1.6	--	nC
Q _{gd}	Gate-Drain Charge		--	3.1	--	nC
Switching Characteristics (Note4)						
t _{d(on)}	Turn-on Delay Time	VDS=10V, VGEN=4.5V, RL=2.7Ω, VGS=10V	--	3.3	--	nS
t _r	Turn-on Rise Time		--	4.8	--	nS
t _{d(off)}	Turn-off Delay Time		--	26.3	--	nS
t _f	Turn-off Fall Time		--	4.1	--	nS
Source- Drain Diode Characteristics @ T_J = 25°C (unless otherwise stated)						
V _{SD}	Forward on voltage (Note3)	IS=1.0A,VGS=0V	--	0.7	1.1	V

Note:

1. Repetitive Rating: Pulse width limited by maximum junction temperature.
2. Surface Mounted on FR4 Board, t ≤ 10 sec
3. Pulse Test: pulse width ≤ 300 us, duty cycle ≤ 2%.
4. Guaranteed by design, not subject to production testing.



30V/5.8A N-Channel Enhancement Mode MOSFET

Typical Characteristics

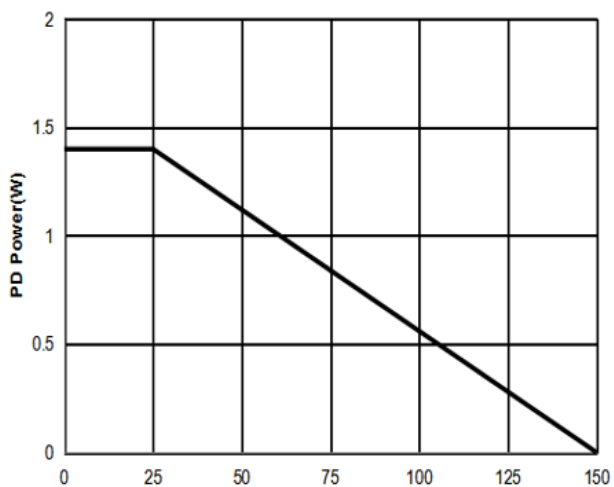

Figure1: Tj Junction Temperature (°C)

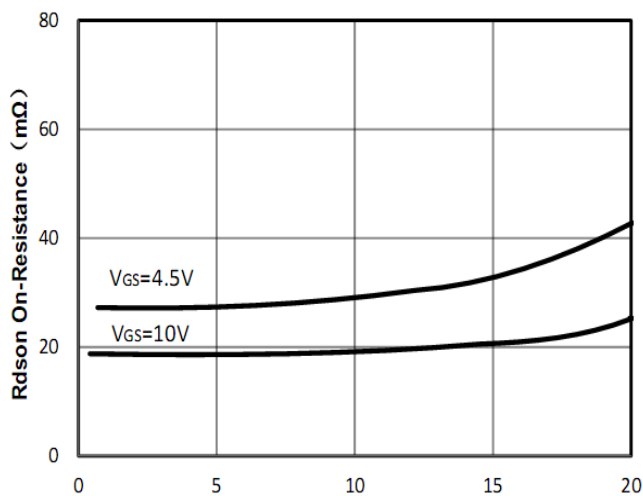

Figure2: Id Drain Current (A)

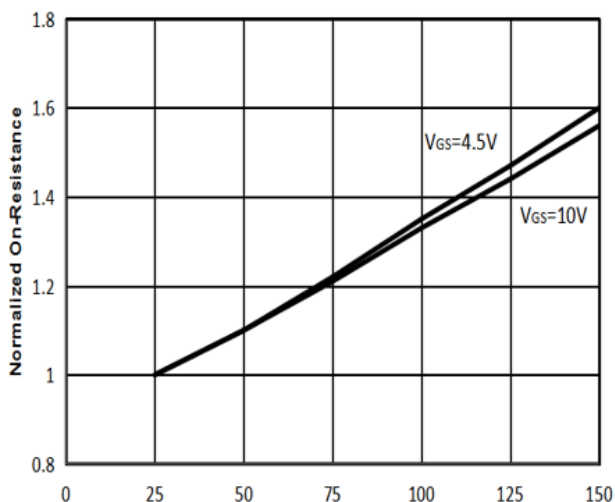

Figure3: Tj Junction Temperature (°C)

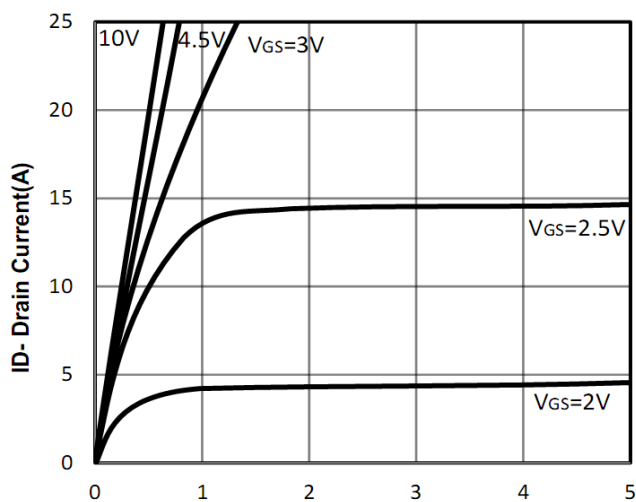

Figure4: Vds Drain-Source Voltage (V)

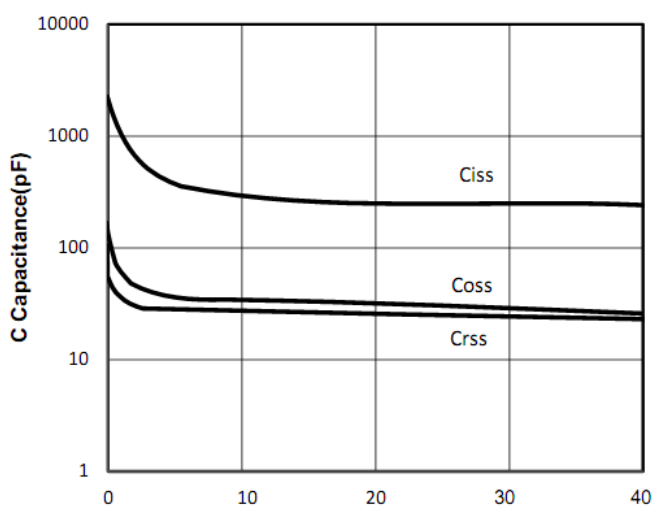

Figure5: Vds Drain-Source Voltage (V)

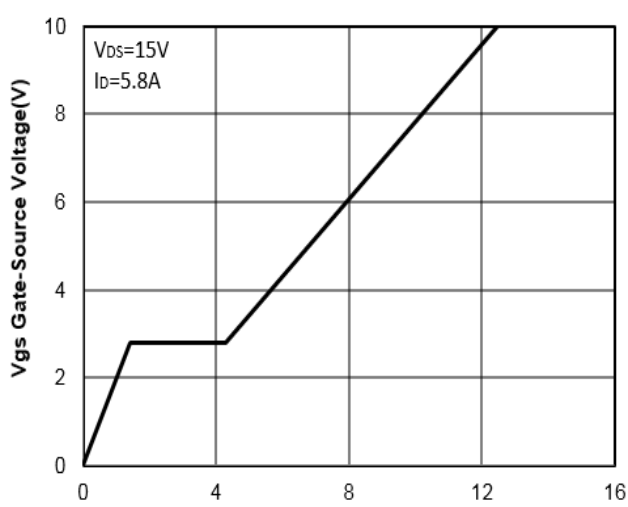

Figure6: Qg Gate Charge (nC)



30V/5.8A N-Channel Enhancement Mode MOSFET

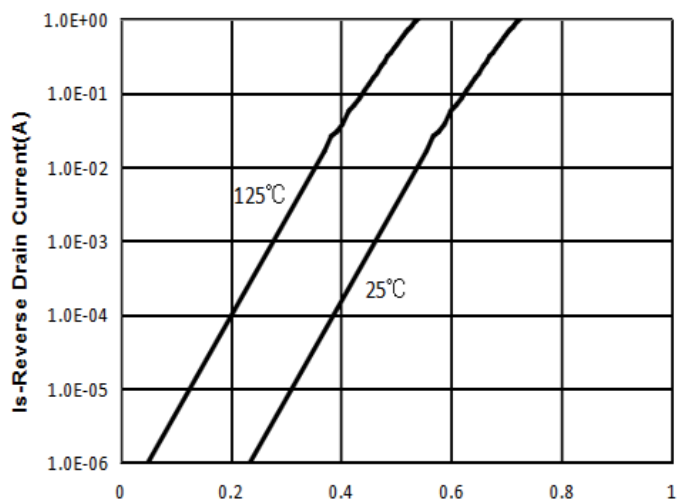

Figure7: Vsd Source-Drain Voltage (V)

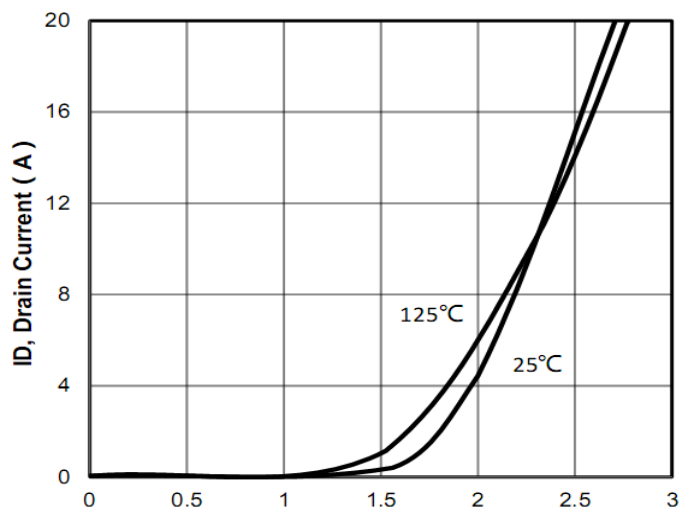

Figure8: Vgs Gate-Source Voltage (V)

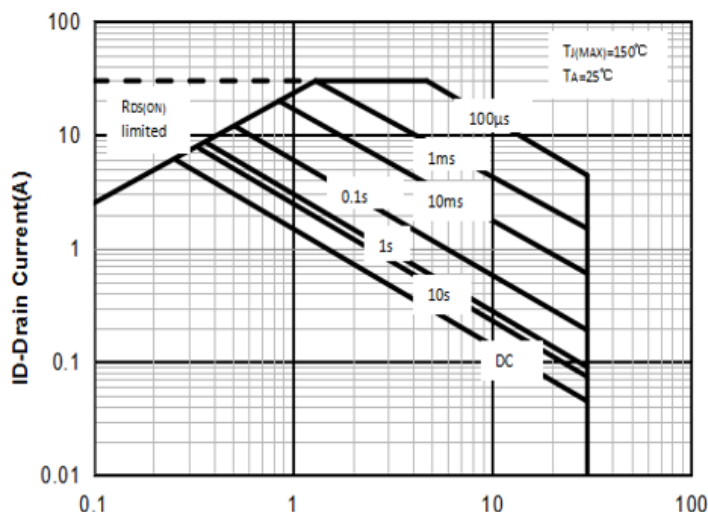

Figure9: Vds Drain -Source Voltage (V)

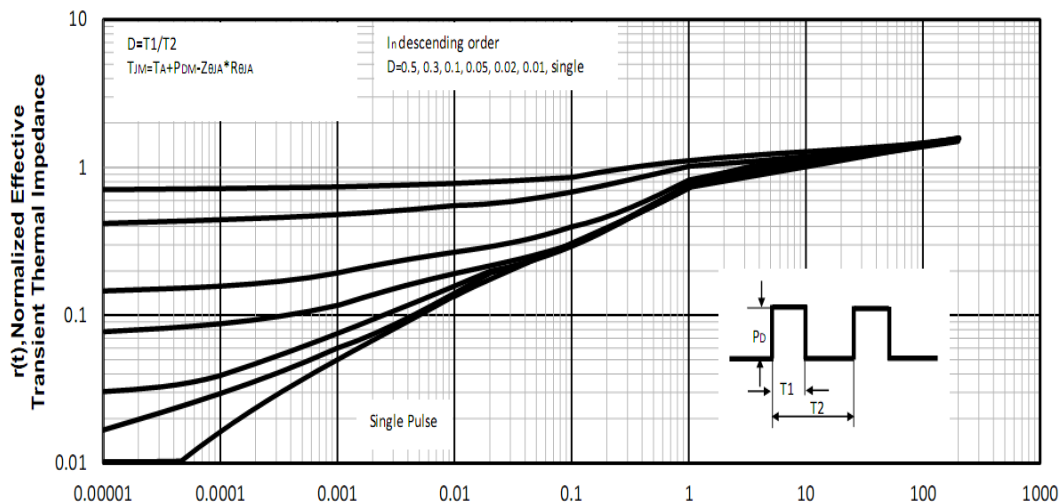

Figure10: Square Wave Pulse Duration (sec)

30V/5.8A N-Channel Enhancement Mode MOSFET

Test Circuit and Waveform:

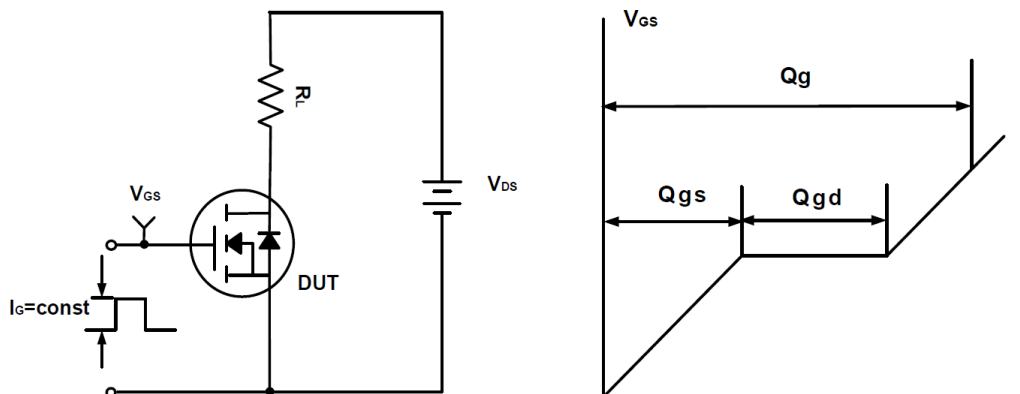

Figure A Gate Charge Test Circuit & Waveforms

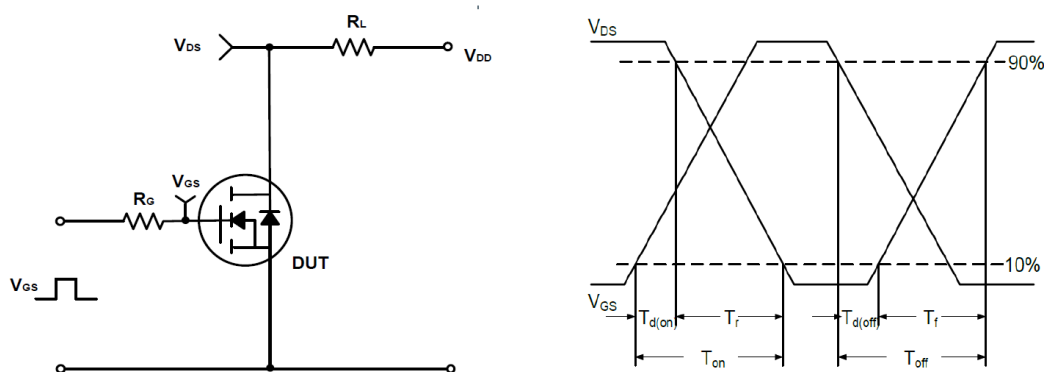

Figure B Switching Test Circuit & Waveforms

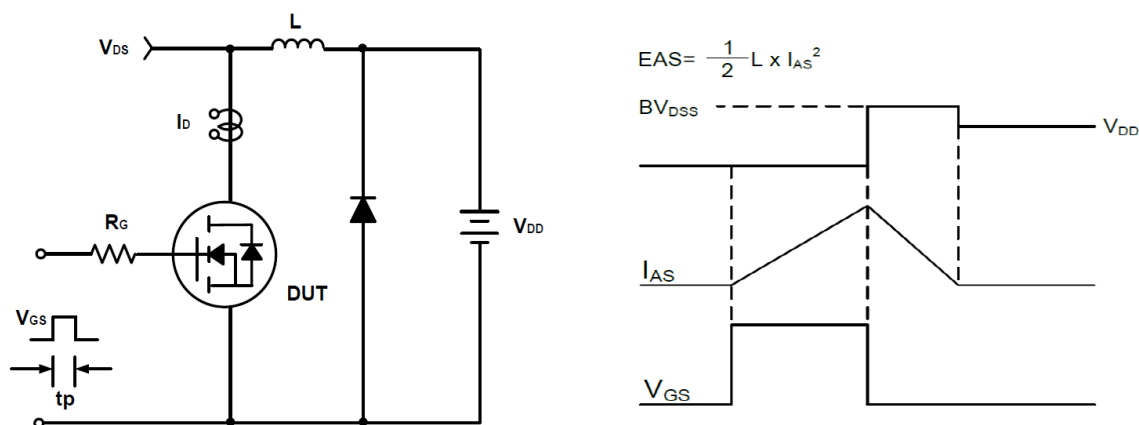
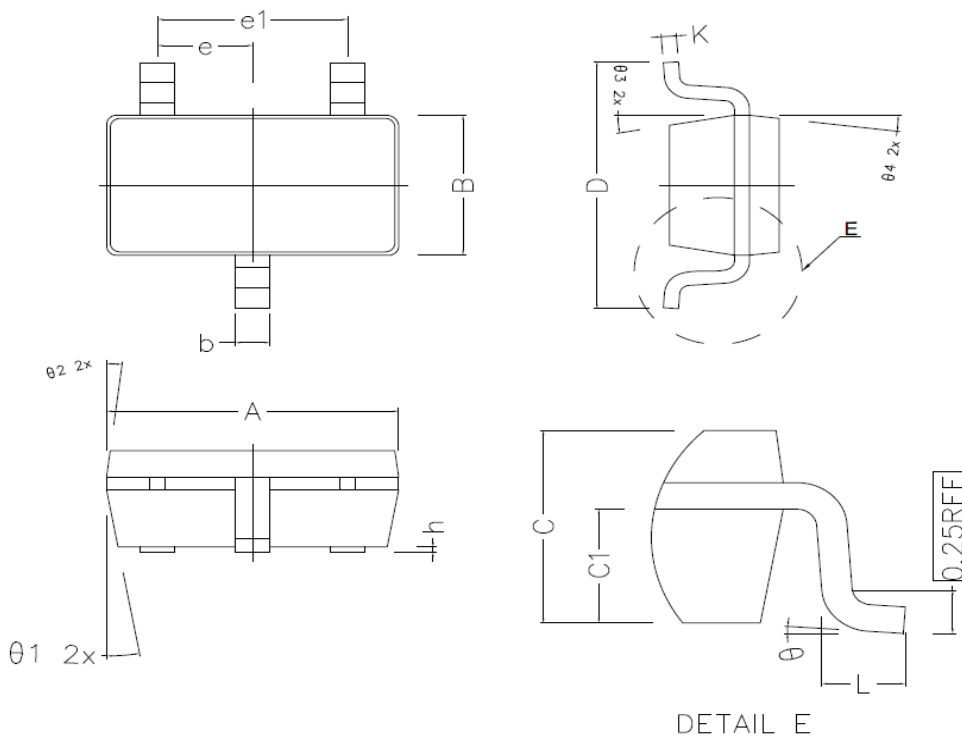

Figure C Unclamped Inductive Switching Circuit & Waveforms

30V/5.8A N-Channel Enhancement Mode MOSFET
SOT-23-3L Package Outline Dimensions (Units: mm)

COMMON DIMENSIONS (UNITS OF MEASURE IS mm)			
	MIN	NORMAL	MAX
A	2.820	2.920	3.020
B	1.500	1.600	1.700
C	1.050	1.100	1.150
C1	0.600	0.650	0.700
D	2.650	2.800	2.950
L	0.300	0.450	0.600
b	0.280	0.350	0.420
h	0.020	0.050	0.100
K	0.120	—	0.230
e	0.950TYPE		
e1	1.900TYPE		
θ_1	10° TYPE		
θ_2	7° TYPE		
θ_3	10° TYPE		
θ_4	7° TYPE		
θ	0° ~ 8°		